

目录

1 适用范围 Scope	2
2 术语 Glossary.....	2
3 型号说明 Part Number System.....	2
4.1 应用示意图 Application Schematic	3
4.2 尺寸 Dimensions (mm).....	4
5 技术参数 Specifications.....	6
6 安规认证 Agency Approvals.....	7
7 检验 Inspection.....	7
7.1 大气条件 Atmospheric Conditions.....	7
7.2 机械特性 Mechanical Performances	7
7.3 常规检验项目 Routine Inspection Items.....	8
7.4 动作负载试验 Operating Duty Test.....	9
7.5 电压保护水平测试 Voltage Protection Level Test.....	9
7.6 暂态过电压下的性能试验. Behavior under temporary overvoltage (TOV)	10
8 安装使用及维护 Installation and maintenance.....	11
9 标示 Marks.....	11
10. 包装 Packaging	12

1 适用范围 Scope

EZ10MF277S(M)-S(C). 适用于 90V~305V AC 交流电系统。

防电涌等级:

IEC 61643-11 : 复合冲击波(Uoc/lcw) · 10kV/5kA ;

IEC 61000-4-5 : 安装于受试设备后 · 复合波冲击波(Uoc/lcw) · 10kV/5kA

L-N 差模 2 ohm · L-G/N-G 共模 12 ohm 。

温度范围 : -40°C ~ 125°C

外壳防护等级 : IP67 ;使用耐高温防火外壳

EZ10MF277S(M)-S(C). are apply to 90V~305V AC system.

Surge protection level:

IEC 61643-11 : Combination impulse wave, 10kV/5kA ;

IEC 61000-4-5 : After installed in EUT, combination impulse wave, 10kV/5kA.

L-N differential mode 2 ohm · L-G/N-G common mode 12 ohm.

Temperature : -40°C ~ 125°C.

Degree of protection provided by the enclosure : IP67 ; Using high temperature resistant and flameproof enclosure

2 术语 Glossary

参考标准 Reference Standards

IEC 61643-11:2011 · EN61643-11 : 2012 · IEC61643-1:2005 · GB/T 18802.1-2011

UL1449 4th ed.: 2014

3 型号说明 Part Number System

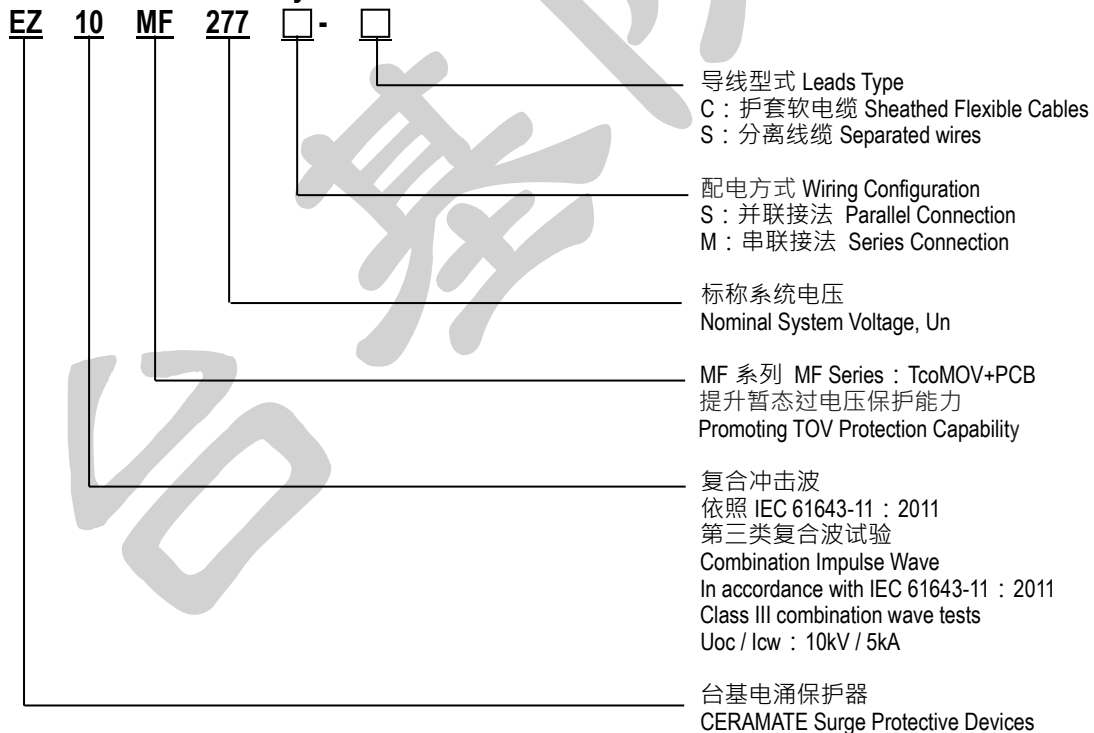

4 结构尺寸 Structure and Dimensions

4.1 应用示意图 Application Schematic

串联接法 Series Connection

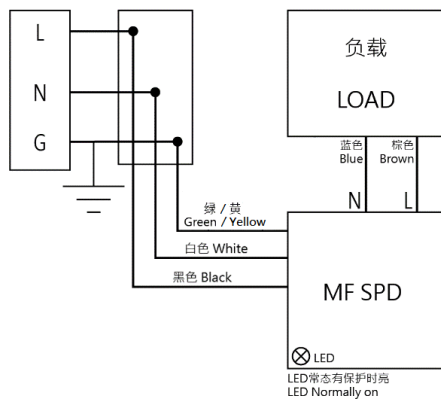

并联接法 Parallel Connection

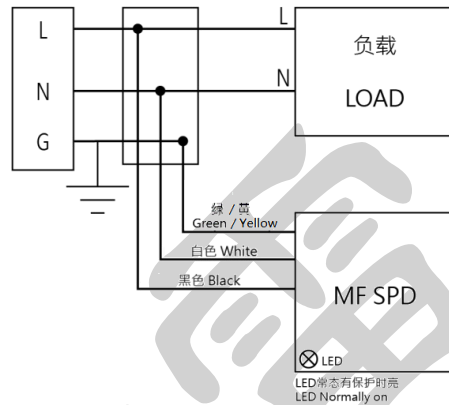

EZ10MF277M-S(C)

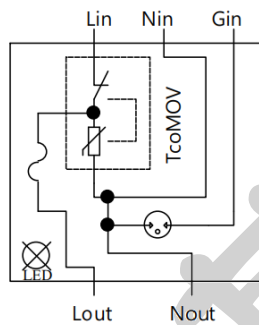

EZ10MF277S-S(C)

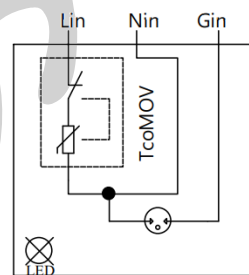

备注: 1. LED 常态有保护时亮。

Note: 1. Under protected LED normally on.

4.2 尺寸 Dimensions (mm)

EZ10MF277M(S)-S(C)

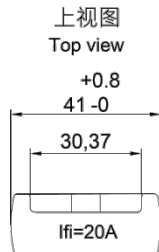

EZ10MF277M(S)-S(C)

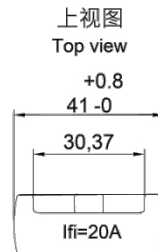

塑胶壳装灌胶防水型(分离线缆)
Plastic casing and potting, waterproof(Separated wires)
EZ10MF277S-S

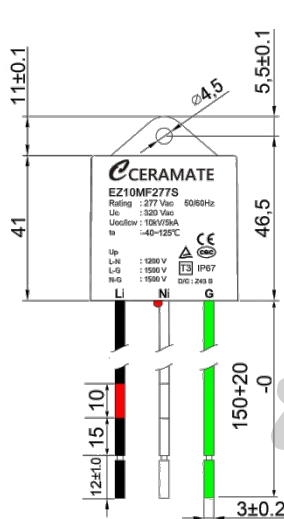

塑胶壳装灌胶防水型(护套软电缆)
Plastic casing and potting, waterproof(Sheathed Flexible Cable)
EZ10MF277S-C

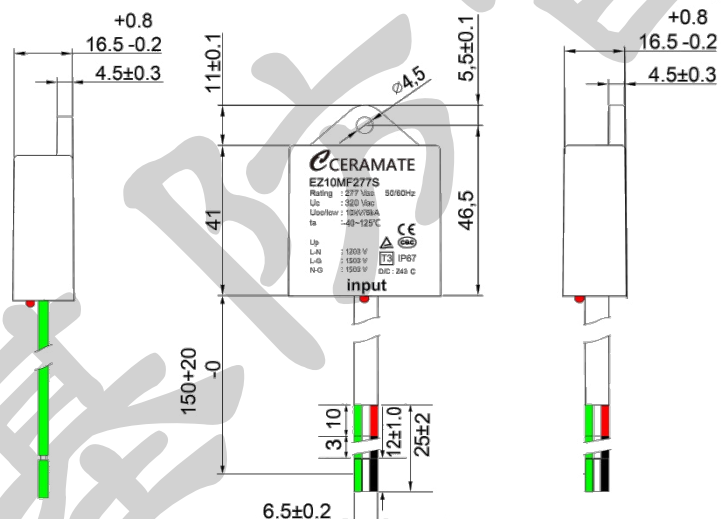

备注：

1. 线规：AWG18 号线。

电线颜色：火线：黑色，零线：白色，地线：绿/黄色，线长：150⁺²⁰₋₀mm。

2. EZ10MF277S-S-(M)：分离线缆，尾端 12.0±1.0 mm 割开不去皮，距割开处约 15mm 套热缩套管，套管规格长 10mm，火线套管颜色为红色，标示“火进”，零线套管颜色为白色，标示“零进”。

EZ10MF277S-C-(M)：护套软电缆，尾端外层割开去皮 25±2mm，内层 12.0±1.0mm 割开不去皮，距割开处约 3mm 套热缩套管，套管规格长 10mm，火线套管颜色为红色，标示“火进”，零线套管颜色为白色，标示“零进”。

Notes：

1. Wire Gauge：AWG18 wire.

Wire Color: Black: Line, White: Neutral, Green/Yellow: Ground. Wire length: 150⁺²⁰₋₀mm.

2. EZ10MF277S-S-(M)：Separated wires, cutting on 12.0±1.0 mm from tail terminals but not stripping. A 10 mm length heat-shrinkable tube is sleeve on the position about 15mm from the cutting position. The tubing color of line is red, and marking as “火进”, The tubing color of neutral is white, and marking as “零进”.

EZ10MF277S-C-(M)：Sheathed flexible cable, Jacket cutting on 25±2mm from tail terminal and stripping, Internal wires cutting on 12.0±1.0mm from tail terminals but not stripping. A 10 mm length heat-shrinkable tube is sleeve on the position about 3mm from the cutting position. The tubing color of line is red, and marking as “火进”, The tubing color of neutral is white, and marking as “零进”.

塑胶壳装灌胶防水型(分离线缆)
Plastic casing and potting, waterproof(Separated wires)
EZ10MF277M-S

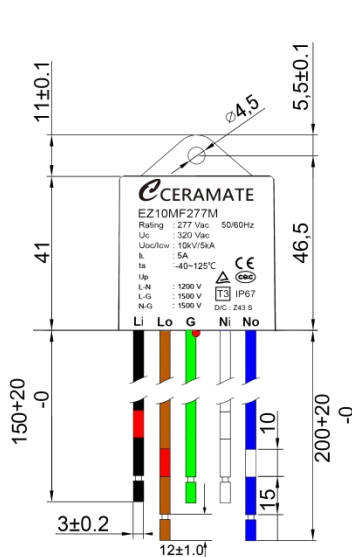

塑胶壳装灌胶防水型(护套软电缆)
Plastic casing and potting, waterproof(Sheathed Flexible Cable)
EZ10MF277M-C

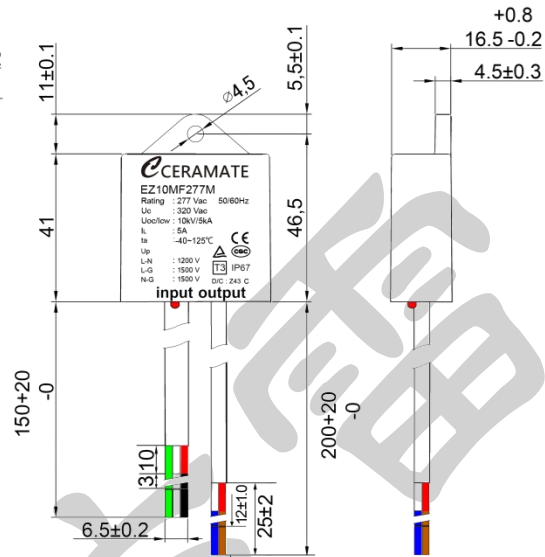

备注：

1. 线规：AWG18 号线

电线颜色：输入：火线：黑色，零线：白色，地线：绿/黄色，线长：150⁺²⁰₀mm。

输出：火线：棕色，零线：蓝色，线长：200⁺²⁰₀mm。

2.EZ10MF277M-S-(M)：分离线缆，尾端 12.0±1.0 mm 割开不去皮，距割开处约 15mm 套热缩套管，套管规格长 10mm,火线套管颜色为红色,标示“火进”或“火出”，零线套管颜色为白色,标示“零进”或“零出”。

EZ10MF277M-C-(M)：护套软电缆，尾端外层割开去皮 25±2mm，内层 12.0±1.0mm 割开不去皮，距割开处约 3mm 套热缩套管，套管规格长 10mm,火线套管颜色为红色,标示“火进”或“火出”，零线套管颜色为白色,标示“零进”或“零出”。

Notes：

1. Wire Gauge：AWG18 wire

Wire Color：Input：Black：Line，White：Neutral，Green/Yellow：Ground，Line length：150⁺²⁰₀mm.

Output：Brown：Line，Blue：Neutral，Line length：200⁺²⁰₀mm.

2. EZ10MF277M-S-(M)：Separated wires，cutting on 12.0±1.0 mm from tail terminals but not stripping. A 10 mm length heat-shrinkable tube is sleeve on the position about 15mm from the cutting position. The tubing color of line is red, and marking as “火进” or “火出”，The tubing color of neutral is white, and marking as “零进” or “零出”.

EZ10MF277M-C-(M)：Sheathed flexible cable，Jacket cutting on 25±2mm from tail terminal and stripping. Internal wires cutting on 12.0±1.0mm from tail terminals but not stripping. A 10 mm length heat-shrinkable tube is sleeve on the position about 3mm from the cutting position. The tubing color of line is red, and marking as “火进” or “火出”，The tubing color of neutral is white, and marking as “零进” or “零出”.

5 技术参数 Specifications

产品型号 Product Model	EZ10MF277S-S(C)	EZ10MF277M-S(C)
温湿度范围 Temperature and Humidity Range	温度：-40°C至 125°C/ 湿度：5%至 95%RH Temperature：-40°C to 125°C / Humidity：5%-95% RH	
端口数量 Number of Ports	—端口,仅输入 one port, only input	—端口,输入/输出 one port, input/output
配电系统 Power Distribution System	TN	
标称系统电压范围 Nominal System Voltage Range, Un	90~305VAC	
最大连续工作电压 Maximum Continuous Operating Voltage, Uc	320VAC	
工作频率 Working Frequency	50/60 Hz	
复合冲击波· IEC 61643-11 Combination Impulse Wave Uoc (1.2 / 50 us) / Icw (8 / 20 us) 备注 1 Note 1	10kV / 5kA	
电压保护水平 Voltage Protection Level, Up (V)	L-N	1200
	L-G	1500
	N-G	1500
额定负载电流 Rated Load Current, I _L (A)	—	5
安全失效模式 Safe Failure Mode	开路模式 Open Circuit Mode (OCM)	
暂态过电压特性, 低压系统故障 Temporary Overvoltage (TOV) Characteristic, LV-system Faults	1) 335 Vac, 5 秒, 耐受模式 5 sec, withstand mode (2) 440 Vac, 120 分钟, 耐受或安全失效模式 120min, withstand mode or safe failure mod	
预期短路电流 Prospective Short-circuit Current, I _{scrr} (A)	300	
脱离器动作指示 Indication of Disconnecter Operation	LED 指示灯由亮变灭, AC 电源断开. LED 常态有保护时亮. LED indicator from light on to light off, and AC network cut-off. Under protected LED normally on.	
外壳防护等级 Ingress Protection Level	IP67	
额定断开续流值 Follow current Interrupting Rating	N-G 模式 20A N-G mode 20A	

备注 1: 电涌保护器安装于受试设备后,
依照 IEC 61643-11 : 2011, III类,
或依照 IEC 61000-4-5 : 2014

- 测试波形: 复合波;
- 同一只产品同时满足,
差模: L-N, 10kV/5kA, 2 ohm
共模: L-G / N-G, 10 kV / 833 A, 12 ohm
- 浪涌次数 (对各耦合路径): 应分别在 0°, 90°, 180° 与
270° 相角施加正、负极性各 5 次;
- 连续脉冲间的时间间隔: 1 分钟或更短;
- 耦合阻抗: 差模 18 μF · 共模 9 μF + 10 Ω ·

Note 1: After installed SPD in EUT,
in according to IEC 61643-11 : 2011, class III,
or in according to IEC 61000-4-5 : 2014

- test waveform: combination wave;
- the same sample be satisfied to.
Differential mode : L-N, 10kV/5kA, 2 ohm
Common mode : L-G / N-G, 10 kV / 833 A, 12ohm
- number of impulses (for each coupling path): five positive and
five negative impulses each at 0°, 90°, 180° and at 270°;
- time between successive impulses: 1 min or less;
- coupling impedance: differential mode 18 μF,
common mode 9 μF + 10 Ω.

6 安规认证 Agency Approvals

认证机构 Agency		标准 Standards	认证号 File NO.	类别 Category	执行标准 Designed to Standards
	CQC	GB/T18802.1-2011	CQC19123218316	Ⅲ类 Class III	<ul style="list-style-type: none"> ● GB18802.1-2011 ● UL 1449 4th Ed : 2014 ● IEC 61643-11 : 2011 ● EN 61643-11 : 2012 ● IEC 61000-4-5 : 2014 ● IEEE C62.41.2-2002
	TUV	EN 61643-11 : 2012	R50439388	Ⅲ类 Class III	
	TUV	IEC 61643-11 : 2011	HU-002607	Ⅲ类 Class III	
	TUV	EN 61643-11 : 2012	R50439388	Ⅲ类 Class III	

7 检验 Inspection
7.1 大气条件 Atmospheric Conditions

温度 Temperature : 5 °C - 35 °C

相对湿度 Relative Humidity : 25%-75%

大气压力 Air pressure: 86 kPa to 106 kPa

7.2 机械特性 Mechanical Performances

项目 Items	试验方法 Test methods/conditions	参考标准 Reference Standards	抽样频率和 接受标准 AQL
拉力 Pull	将待测试产品安装于测试架上,所有输入或输出导线从任意角度施加总重 89N(20 磅)的法码挂钩绑牢,受力时间 1 分钟,轻放法码。 Install the product on the test shelf and tie all input or output lead wires respectively with 89N(20 lbf) weight from any angle for 1 minute. Then release the weights slightly.	IEC 61643-11 GB 18802.1	3 pcs/Lot, AC=0 导线不损伤、脱落。 The lead wires shouldn't be damaged.

7.3 常规检验项目 Routine Inspection Items

序号 No.	项目 Items	试验要求 Test Requirements	参考标准 Reference Standards	抽样频率和 接受标准 AQL
1	外观 Appearance	壳体无穿孔,飞边;引脚镀层良好,无氧化发黑等情况。 The case without perforation, flash, the pin coating is good and no oxidative blackening.	ISO 2768-1 GB/T 1804	G-II, AQL=1.0
2	尺寸 Dimension	用游标卡尺测量引脚外露长度·尺寸范围参照 4.2。 Use vernier caliper to measure the Pin out length, size range reference 4.2.	ISO 2768-1 GB/T 1804	S-2, AQL=0.65
3	介电耐压 Dielectric Withstand	在引脚和外壳间施加工频电压 ≥ 2200 V·1 分钟,不应该发生闪络和击穿 Subject the voltage no less than 2200 V, last for 1 minute between leads and enclosure, arcing or puncturing shall not occur.	IEC 61643-11 GB 18802.1	S-2, AQL=1.0
4	动作负载试验 Operating Duty Test	参见第 7 章节《检验》第 7.4 条 Reference 7.4 of the chapter 7 《Inspection》	IEC 61643-11 GB 18802.1	3 PCS/Lot AC=0
5	电压保护水平测试 Voltage Protection Level Test	参见第 7 章节《检验》第 7.5 条 Reference 7.5 of the chapter 7 《Inspection》	IEC 61643-11 GB 18802.1	3 PCS/Lot AC=0
6	暂态过电压特性, 低压系统故障 Temporary Overvoltage (TOV) Characteristic, LV-system faults	参见第 7 章节《检验》第 7.6 条 Reference 7.6 of the chapter 7 《Inspection》	IEC 61643-11 GB 18802.1	3 PCS/Lot AC=0

7.4 动作负载试验 Operating Duty Test

测试方法：将防雷器接入测试端，冲击 2 次 U_{oc} （正、负极各 1 次）测试限制电压，再施加 15 次 U_{oc} 冲击，分成 3 组，每组 5 次冲击。两次冲击之间的间隔时间为 50s~60s，两组之间的间隔时间为 30min。两组冲击之间试品无需施加电压。在施加每组冲击之后，需继续加电至少一分钟来检查复燃。在最后一组冲击和继续加电一分种后，SPD 保持加电，或在少于 30 秒内加电到 U_c ，保持 15 分钟来检查稳定性。30 分钟后再重复进行测试限制电压的程序。

Test Method: Terminal wires of the SPD shall be subjected to one sequence of positive polarity and one sequence of negative polarity at U_{oc} to determine the measured limiting voltage. And then three groups of five impulses of U_{oc} impulses with positive polarity shall be applied. The interval between the impulses is 50 s ~ 60 s, the interval between the groups is 30 min. It is not required that the test sample is energized between the groups. The SPD shall be energized at U_c . After the application of each group of impulses, the SPD shall remain energized without interruption for at least 1 min to check for reignition. After the last group of impulses and the 1 min period the SPD either remains applied or is reapplied within less than 30 s to U_c for another 15 min to check for stability. 30 minutes later, the SPD shall be subjected to sequences to determine the measured limiting voltage repeatedly.

判定标准：产品在测试中不能有可见可闻的损坏，测试前后限制电压的变化率 < 10%。

Pass Criteria: During and following the surge test, there shall not have visible or smelt (or both) damage, and the rate of the clamping voltage's variation shall be less than 10%.

7.5 电压保护水平测试 Voltage Protection Level Test

测试方法：将防雷器接入测试端，冲击 4 次 U_{oc} （正、负极性各 2 次）测试限制电压；若是回路中有 GDT 时，应依次施加峰值约为 0.1；0.2；0.5；1.0 的 U_{oc} 冲击电压（正、负极性各 2 次）测试限制电压。每次冲击的间隔时间应足以使试品冷却到环境温度。

Test Method: Terminal wires of the SPD shall be subjected to one sequence of positive polarity and one sequence of negative polarity to determine the measured limiting voltage; If there is a GDT component in the circuit, 8/20 current impulses with two sequence of crest values of approximately 0,1; 0,2; 0,5; 1,0 times I_n shall be applied to determine the measured limiting voltage. After each impulse, the rest time should be let samples cooled to the ambient temperature.

判定标准：电压和电流波形图及目测检测试品应没有击穿或闪络的现象；试验过程中不应发生可见损害；不应对人体或设备产生爆炸或其他危险；试验后试品 U_{oc} 测试时的限制电压值小于或等于 U_p 。

Pass Criteria: Voltage and current records and visual inspection shall show no indication of puncture or flashover. No visible damage shall occur during the test. Values for measured limiting voltage after the test of U_{oc} shall be below or equal to U_p .

7.6 暂态过电压下的性能试验. Behavior under temporary overvoltage (TOV) .**低压系统故障. Low voltage system faults .**

测试方法：SPD 试品应连接到 U_T 的工频电压，持续时间为 t_T 秒。 U_T 电源应能输出足够大的电流，以确保在试验过程中 SPD 端子上的电压不会跌落低于 U_T 的 5%。紧接着在施加 U_T 后，应在试品上施加等于 U_{REF} 并具有同样电流能力的电压 15 分钟。试验周期之间的时间间隔应尽可能短，并且在任何情况下不应超过 100ms。

TOV 试验参数：(1) 335 Vac, 5 秒, 耐受模式。

(2) 440 Vac, 120min, 耐受或安全失效模式。

Test Method: The test sample shall be connected to a power frequency voltage of U_T for a duration t_T seconds. This power source for U_T , shall be capable of delivering a current high enough to ensure that the voltage at the SPD terminals does not fall below U_T by more than 5% during the test. Immediately following the application of U_T , a voltage equal to U_{REF} with the same current capability, shall be applied to the test sample for a period of 15 min. The time interval between the test periods shall be as short as possible and shall in any case not exceed 100 ms.

TOV Test Parameters : (1) 335 Vac, 5 Sec, withstand mode .

(2) 440 Vac, 120min, withstand or safe failure mode .

判定标准：必须达到热稳定。试品应没有击穿或闪络的迹象。试验过程中不应发生可见的损害。试验后检查发现的细小的凹痕或裂缝如不影响防直接接触，则可以忽略。试验后试品上不应有燃烧的痕迹。试验时内部脱扣装置不应动作；试验后脱扣装置应处在正常工作状态。

Pass Criteria: Thermal stability shall be achieved. The sample shall show no indication of puncture or flashover. No visible damage shall occur during the test. After the test, small indents and cracks not impairing the protection against direct contact are disregarded during this check. There shall be no visual evidence of burning of the sample after the test. Internal disconnectors shall not operate during the test and shall be in working order after the test.

8 安装使用及维护 Installation and maintenance

- 8.1 EZ10MF277M-S(C) 串联接法,一端口,输入/输出。
EZ10MF277M-S(C) Series connection one port, input / output.
- EZ10MF277S-S(C) 并联接法,一端口,仅输入
EZ10MF277S-S(C) Parallel connection, one port, only input
- 8.2 不正确的安装可能会损坏 SPD 的性能,严格按照指示安装尤为重要。
Incorrect installation may damage the performance of the SPD, and it is especially important to follow the instructions.
- 8.3 在开始安装程序之前,需用电表验证工作电压(AC 或 DC),以确保工作电压符合要求。
Before starting the installation procedure, use the meter to verify the operating voltage (AC or DC) to ensure that the operating voltage meets the requirements.
- 8.4 如果测量的电压超过电涌保护器的额定值,请勿安装 SPD。
Do not install SPD if the measured voltage exceeds the rating of the surge protector.
- 8.5 安装前不要接入电力系统。
Do not connect the power system before installation.
- 8.6 该电涌保护器在通电时 LED 灯应亮,如果 LED 灯不亮,说明电涌保护器已经损坏,需维修或更换。
The LED indicator should be light up when the surge protector is energized. If the LED indicator does not light, it indicates that the surge protector is damaged and needs to be repaired or replaced.

9 标示 Marks

本体标示 Product Body Marking:

例如 ex:

EZ10MF277M(S)-S(C)

EZ10MF277M(S)-S(C)

上视图
Top view

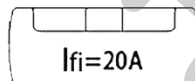

上视图
Top view

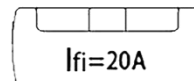

分离线缆
Separated wires

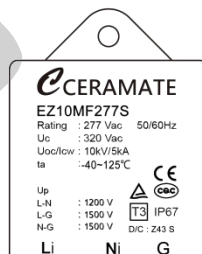
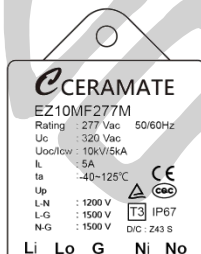

护套软电缆
Sheathed Flexible Cable

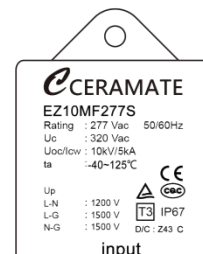
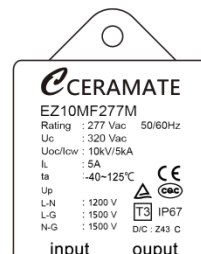

10. 包装 Packaging

<p>EZ10MF277S-S 塑胶壳装灌胶防水型 Plastic casing and potting, waterproof (350×260×150mm) 144 PCS/纸箱 Carton</p>	
<p>EZ10MF277M-S 塑胶壳装灌胶防水型 Plastic casing and potting, waterproof (350×260×150mm) 128 PCS/纸箱 Carton</p>	
<p>EZ10MF277S(M)-C 塑胶壳装灌胶防水型 Plastic casing and potting, waterproof (350×260×150mm) 90 PCS/纸箱 Carton</p>	